

USER MANUAL

ON/OFF GRID SOLAR INVERTER 3.6KW/4.2KW/6.2KW



RV-3.6KW-M/RV-4.2KW-M



RV-6.2KW-M

Table Of Contents

1	ABOUT THIS MANUAL.....	3
1.1	PURPOSE.....	3
1.2	SCOPE.....	3
2	SAFETY INSTRUCTIONS.....	3
3	INTRODUCTION.....	4
3.1	FEATURES.....	4
3.2	BASIC SYSTEM ARCHITECTURE.....	4
3.3	PRODUCT OVERVIEW.....	5
4	INSTALLATION.....	6
4.1	UNPACKING AND INSPECTION.....	6
4.2	PREPARATION.....	6
4.3	MOUNTING THE UNIT.....	6
4.4	BATTERY CONNECTION.....	6
4.5	AC INPUT/OUTPUT CONNECTION.....	8
4.6	PV CONNECTION.....	9
4.7	FINAL ASSEMBLY.....	11
4.8	COMMUNICATION CONNECTION.....	11
5	OPERATION.....	11
5.1	POWER ON/OFF.....	11
5.2	OPERATION AND DISPLAY PANEL.....	11
5.3	LCD DISPLAY ICONS.....	12
5.4	LCD SETTING.....	14
5.5	DISPLAY SETTING.....	21
5.6	OPERATING MODE DESCRIPTION.....	25
5.7	BATTERY EQUALIZATION DESCRIPTION.....	26
5.8	FAULT REFERENCE CODE.....	27
5.9	WARNING INDICATOR.....	28
6	CLEARANCE AND MAINTENANCE FOR ANTI-DUST KIT.....	29
6.1	OVERVIEW.....	29
6.2	CLEARANCE AND MAINTENANCE.....	29
7	SPECIFICATIONS.....	30
	TABLE 1 LINE MODE SPECIFICATIONS.....	31
	TABLE 2 INVERTER MODE SPECIFICATIONS.....	32
	TABLE 3 CHARGE MODE SPECIFICATIONS.....	33
	TABLE 4 Grid-Tie Operation	33
	TABLE 5 GENERAL SPECIFICATIONS.....	33
8	TROUBLE SHOOTING.....	33
9	APPENDIX: APPROXIMATE BACK-UP TIME TABLE.....	34

1 ABOUT THIS MANUAL

1.1 Purpose

This manual describes the assembly, installation, operation and troubleshooting of this unit. Please read this manual carefully before installations and operations. Keep this manual for future reference.

1.2 Scope

This manual provides safety and installation guidelines as well as information on tools and wiring.

2 SAFETY INSTRUCTIONS



WARNING: This chapter contains important safety and operating instructions. Read and keep this manual for future reference.

1. Before using the unit, read all instructions and cautionary markings on the unit, the batteries and all appropriate sections of this manual.
2. **CAUTION** --To reduce risk of injury, charge only deep-cycle lead acid type rechargeable batteries. Other types of batteries may burst, causing personal injury and damage.
3. Do not disassemble the unit. Take it to a qualified service center when service or repair is required. Incorrect re-assembly may result in a risk of electric shock or fire.
4. To reduce risk of electric shock, disconnect all wirings before attempting any maintenance or cleaning. Turning off the unit will not reduce this risk.
5. **CAUTION** – Only qualified personnel can install this device with battery.
6. **NEVER** charge a frozen battery.
7. For optimum operation of this inverter/charger, please follow required spec to select appropriate cable size. It's very important to correctly operate this inverter/charger.
8. Be very cautious when working with metal tools on or around batteries. A potential risk exists to drop a tool to spark or short circuit batteries or other electrical parts and could cause an explosion.
9. Please strictly follow installation procedure when you want to disconnect AC or DC terminals. Please refer to INSTALLATION section of this manual for the details.
10. One piece of 150A fuse is provided as over-current protection for the battery supply.
11. **GROUNDING INSTRUCTIONS** -This inverter/charger should be connected to a permanent grounded wiring system. Be sure to comply with local requirements and regulation to install this inverter.
12. **NEVER** cause AC output and DC input short circuited. Do NOT connect to the mains when DC input short circuits.
13. **Warning!!** Only qualified service persons are able to service this device. If errors still persist after following troubleshooting table, please send this inverter/charger back to local dealer or service center for maintenance.

3 INTRODUCTION

This is a multi-function inverter/charger, combining functions of inverter, solar charger and battery charger to offer uninterruptible power support with portable size. Its comprehensive LCD display offers user-configurable and easy-accessible button operation such as battery charging current, AC/solar charger priority, and acceptable input voltage based on different applications.

3.1 Features

- ☒ Pure sine wave inverter
- ☒ Configurable input voltage range for home appliances and personal computers via LCD setting
- ☒ Configurable battery charging current based on applications via LCD setting
- ☒ Configurable AC/Solar Charger priority via LCD setting
- ☒ Compatible to mains voltage or generator power
- ☒ Auto restart while AC is recovering
- ☒ Overload/ Over temperature/ short circuit protection
- ☒ Smart battery charger design for optimized battery performance
- ☒ Cold start function

3.2 Basic System Architecture

The following illustration shows basic application for this inverter/charger. It also includes following devices to have a complete running system:

- ☒ Generator or Utility.
- ☒ PV modules

Consult with your system integrator for other possible system architectures depending on your requirements. This inverter can power all kinds of appliances in home or office environment, including motor-type appliances such as tube light, fan, refrigerator and air conditioner.

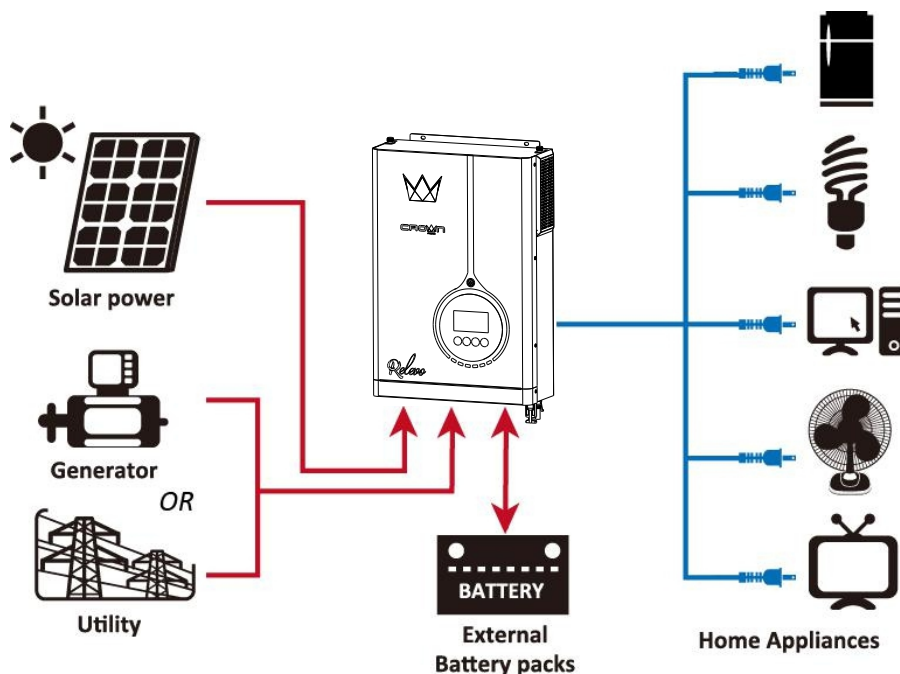
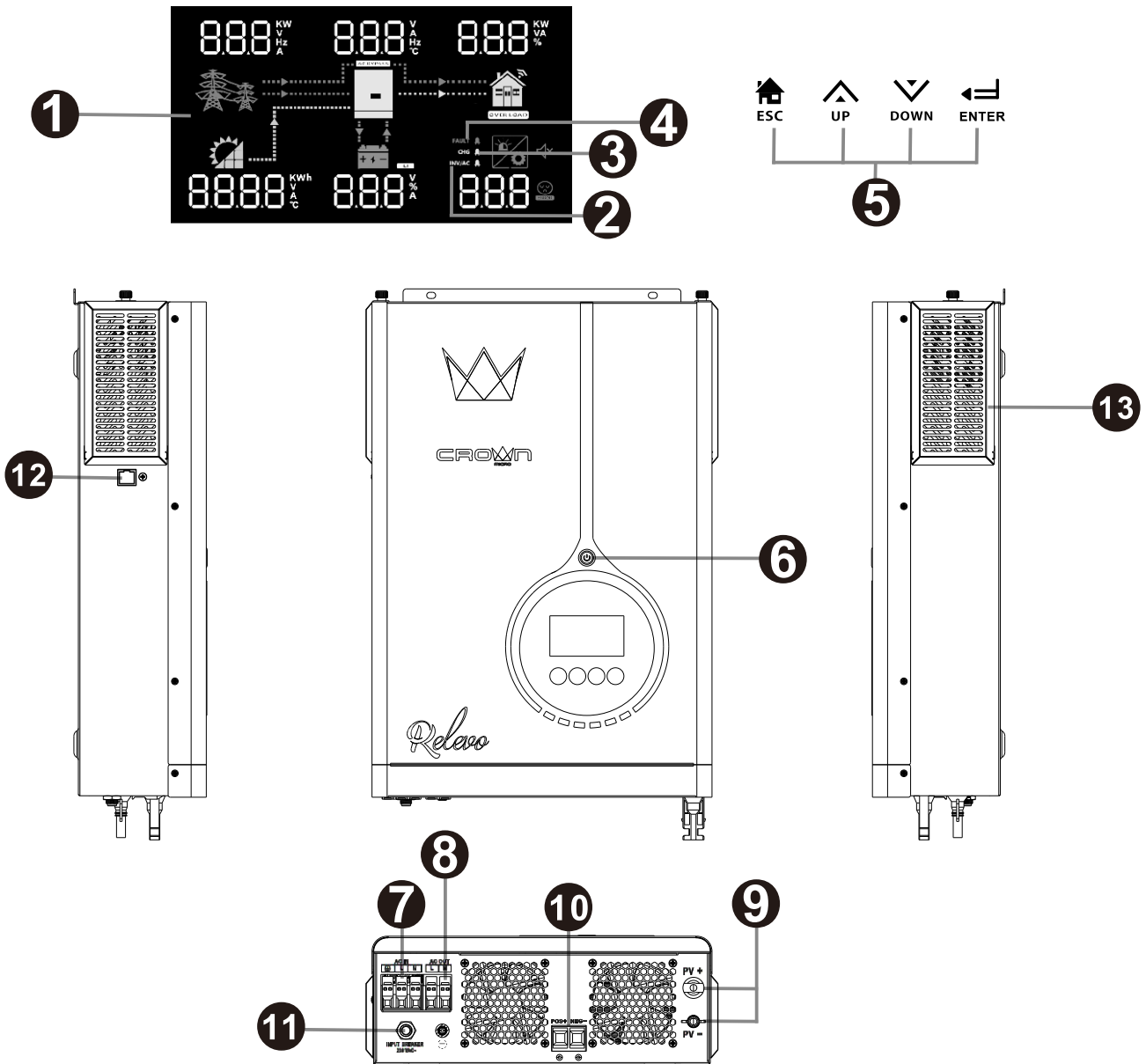

Figure 1 Hybrid Power System

3.3 Product Overview



1. LCD display
2. Status indicator
3. Charging indicator
4. Fault indicator
5. Function buttons
6. Power on/off switch
7. AC input
8. AC output
9. PV input
10. Battery input
11. Circuit breaker
12. RS-232 communication port /WiFi-port
13. Anti dust kit(Optional)

4 INSTALLATION

4.1 Unpacking and Inspection

Before installation, please inspect the unit. Be sure that nothing inside the package is damaged. You should have received the following items inside of package:

- The unit x 1
- User manual x 1
- DC Fuse x 1
- Ring terminal x 1

4.2 Preparation

Before connecting all wirings, please take off bottom cover by removing two screws as shown below.

4.3 Mounting the Unit

Consider the following points before selecting where to install:

- ⌘ Do not mount the inverter on flammable construction materials.
- ⌘ Mount on a solid surface
- ⌘ Install this inverter at eye level in order to allow the LCD display to be read at all times.
- ⌘ For proper air circulation to dissipate heat, allow a clearance of approx. 20 cm to the side and approx. 50 cm above and below the unit.
- ⌘ The ambient temperature should be between 0°C and 55°C to ensure optimal operation.
- ⌘ The recommended installation position is to be adhered to the wall vertically.
- ⌘ Be sure to keep other objects and surfaces as shown in the diagram to guarantee sufficient heat dissipation and to have enough space for removing wires.

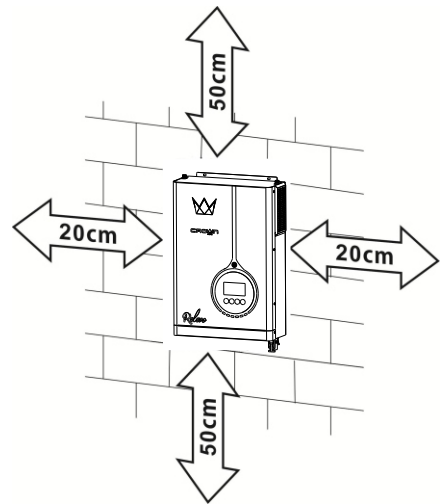

SUITABLE FOR MOUNTING ON CONCRETE OR OTHER NON-COMBUSTIBLE SURFACE ONLY.

Install the unit by screwing two screws. It's recommended to use M4 or M5 screws.

4.4 Battery Connection

CAUTION: For safety operation and regulation compliance, it's requested to install a separate DC over-current protector or disconnect device between battery and inverter. It may not be requested to have a disconnect device in some applications, however, it's still requested to have over-current protection installed. Please refer to typical amperage in below table as required fuse or breaker size.

WARNING! All wiring must be performed by a qualified personnel.

WARNING! It's very important for system safety and efficient operation to use appropriate cable for battery connection. To reduce risk of injury, please use the proper recommended cable as below.

Recommended battery cable size:

Model	Wire Size	Cable (mm ²)	Torque value (max)
3.6KW/4.2KW/6.2KW	1 x 2AWG	25	2 Nm

Please follow below steps to implement battery connection:

1. Remove insulation sleeve 18 mm for positive and negative conductors.
2. Suggest to put bootlace ferrules on the end of positive and negative wires with a proper crimping tool.

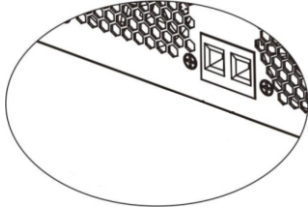
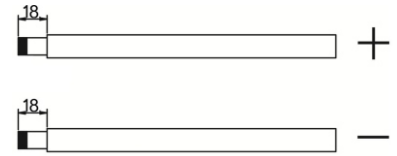

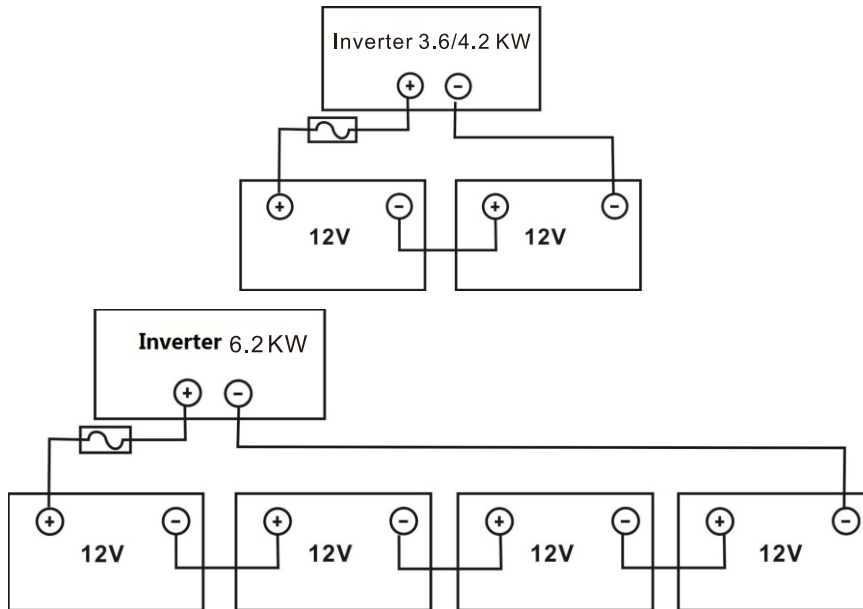

3. Connect all battery packs as below chart.

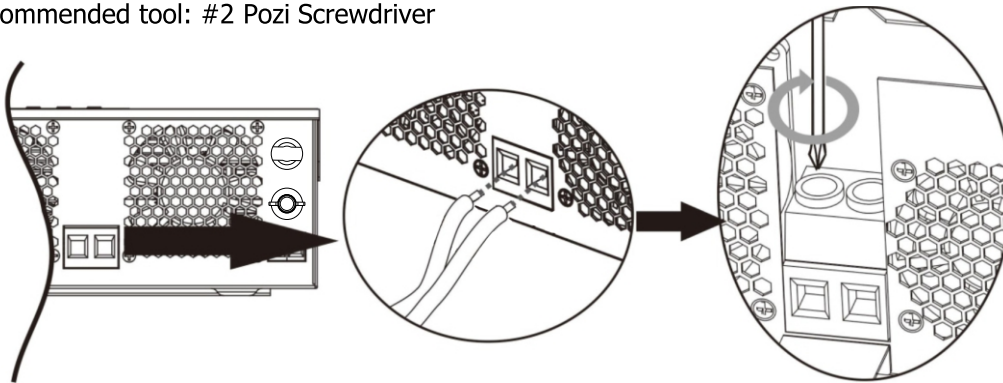

4. Insert the battery wires flatly into battery connectors of inverter and make sure the bolts are tightened with torque of 2 Nm in clockwise direction. Make sure polarity at both the battery and the inverter/charge is correctly connected and conductors are tightly screwed into the battery terminals.

Recommended tool: #2 Pozi Screwdriver



 **WARNING: Shock Hazard**
Installation must be performed with care due to high battery voltage in series.

 **CAUTION!!** Before making the final DC connection or closing DC breaker/disconnector, be sure positive (+) must be connected to positive (+) and negative (-) must be connected to negative (-).

4.5 AC Input/Output Connection

CAUTION!! Before connecting to AC input power source, please install a **separate** AC breaker between inverter and AC input power source. This will ensure the inverter can be securely disconnected during maintenance and fully protected from over current of AC input. The recommended spec of AC breaker is 32A for 3.6KW/4.2KW and 50A for 6.2KW.

CAUTION!! There are two terminal blocks with "IN" and "OUT" markings. Please do NOT mis-connect input and output connectors.

WARNING! All wiring must be performed by a qualified personnel.

WARNING! It's very important for system safety and efficient operation to use appropriate cable for AC input connection. To reduce risk of injury, please use the proper recommended cable size as below.

Suggested cable requirement for AC wires

Model	Gauge	Cable (mm ²)	Torque Value
3.6KW/4.2KW	12 AWG	4	1.2 Nm
6.2KW	10 AWG	6	1.2 Nm

Please follow below steps to implement AC input/output connection:

1. Before making AC input/output connection, be sure to open DC protector or disconnecter first.
2. Remove insulation sleeve 10mm for six conductors. And shorten phase L and neutral conductor N 3 mm.
3. Insert AC input wires according to polarities indicated on terminal block and tighten the terminal screws. Be sure to connect PE protective conductor (⊕) first.

⊕ → **Ground (yellow-green)**
L → **LINE (brown or black)**
N → **Neutral (blue)**

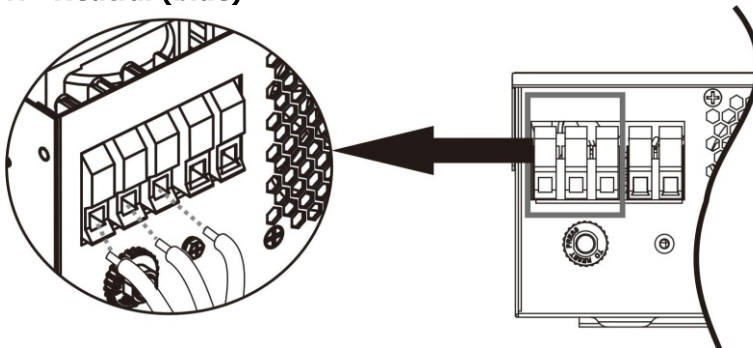

WARNING: Be sure that AC power source is disconnected before attempting to hardwire it to the unit.

4. Then, insert AC output wires according to polarities indicated on terminal block and tighten terminal screws.

L → **LINE (brown or black)**
N → **Neutral (blue)**

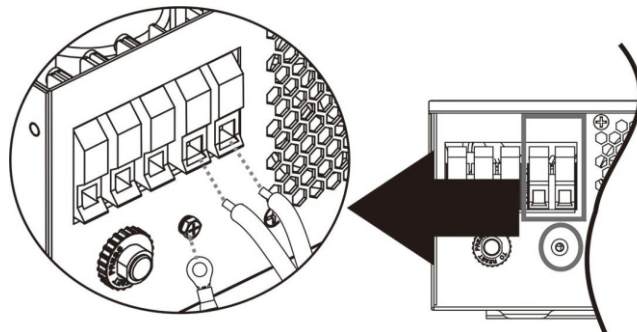

5. Make sure the wires are securely connected.

CAUTION: Appliances such as air conditioner are required at least 2~3 minutes to restart because it's required to have enough time to balance refrigerant gas inside of circuits. If a power shortage occurs and recovers in a short time, it will cause damage to your connected appliances. To prevent this kind of damage, please check manufacturer of air conditioner if it's equipped with time-delay function before installation. Otherwise, this inverter/charger will trig overload fault and cut off output to protect your appliance but sometimes it still causes internal damage to the air conditioner.

4.6 PV Connection

CAUTION: Before connecting to PV modules, please install **separately** a DC circuit breaker between inverter and PV modules.

WARNING! It's very important for system safety and efficient operation to use appropriate cable for PV module connection. To reduce risk of injury, please use the proper recommended cable size as below.

Model	Wire Size	Cable (mm ²)	Torque value (max)
3.6KW/4.2KW/6.2KW	1 x 12AWG	4	1.2 Nm

PV Module Selection:

When selecting proper PV modules, please be sure to consider below parameters:

1. Open circuit Voltage (Voc) of PV modules not exceeds max. PV array open circuit voltage of inverter.
2. Open circuit Voltage (Voc) of PV modules should be higher than min. battery voltage.

INVERTER MODEL	3.6KW	4.2KW	6.2KW
Max. PV Array Open Circuit Voltage	500Vdc		
PV Array MPPT Voltage Range	90Vdc~450Vdc		

Take 250Wp PV module as an example. After considering above two parameters, the recommended module configurations are listed as below table.

Solar Panel Spec. (reference)	SOLAR INPUT		Q'ty of panels	Total input power
	(Min in serial: 6 pcs, max. in serial: 13 pcs)			
- 250Wp	6 pcs in serial		6 pcs	1500W
- Vmp: 30.1Vdc	8 pcs in serial		8 pcs	2000W
- Imp: 8.3A	12 pcs in serial		12 pcs	3000W
- Voc: 37.7Vdc	13 pcs in serial		13 pcs	3250W
- Isc: 8.4A	8 pieces in serial and 2 sets in parallel		16 pcs	4000W
- Cells: 60	10 pieces in serial and 2 sets in parallel		20 pcs	5000W
	10 pieces in serial and 2 sets in parallel		20 pcs	6200W
	12 pieces in serial and 2 sets in parallel		24 pcs	6500W

PV Module Wire Connection

Step 1: Check the input voltage of PV array modules. The acceptable input voltage of the inverter is 120VDC - 500VDC. Please make sure that the maximum current load of each PV input connector is 10A.

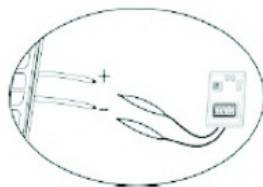





CAUTION: Exceeding the maximum input voltage can destroy the unit!! Check the system before wire connection.

Step 2: Disconnect the DC circuit breaker.

Step 3: Assemble provided PV connectors with PV modules by the following below steps.

Components for PV connectors and Tools:

Female connector housing		Male terminal	
Female terminal		Crimping tool and spanner	
Male connector housing			

Cable preparation and connector assembly process:

Strip one cable 8 mm on both end sides and be careful NOT to nick conductors.

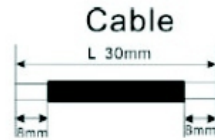

Insert striped cable into female terminal and crimp female terminal as shown below charts.



Insert assembled cable into female connector housing as shown below charts.

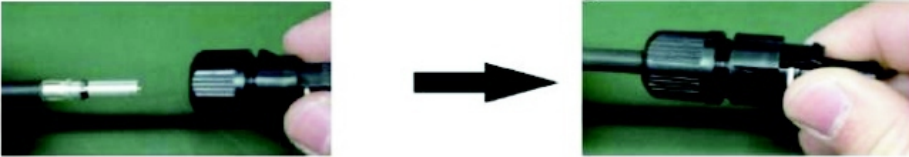

Insert striped cable into male terminal and crimp male terminal as shown below charts.



Insert assembled cable into male connector housing as shown below charts.

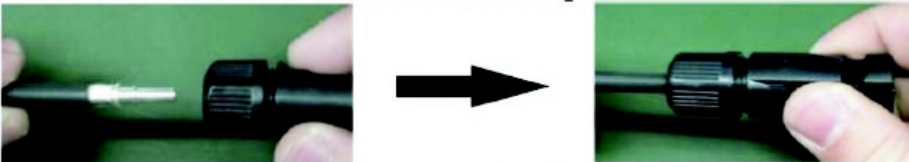

Then, use spanner to screw pressure dome tightly to female connector and male connector as shown below.

Step 4: Check correct polarity of connection cable from PV modules and PV input connectors. Then, connect positive pole (+) of connection cable to positive pole (+) of PV input connector. Connect negative pole (-) of connection cable to negative pole (-) of PV input connector.

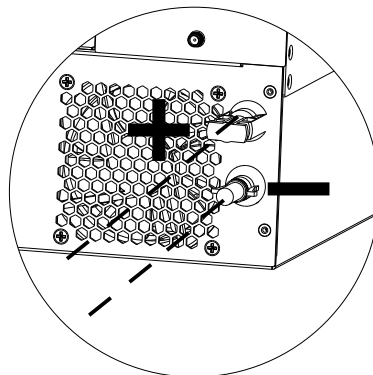

4.7 Final Assembly

After connecting all wirings, please put bottom cover back by screwing two screws as shown below.

4.8 Communication Connection

1. Wi-Fi cloud communication (option):

Please use supplied communication cable to connect to inverter and Wi-Fi module. Download APP and installed from APP store, and Refer to "Wi-Fi Plug Quick Installation Guideline" to set up network and registering. The inverter status would be shown by mobile phone APP or webpage of computer.

2. GPRS cloud communication (option):

Please use supplied communication cable to connect to inverter and GPRS module, and then applied external power to GPRS module. Download APP and installed from APP store, and Refer to "GPRS RTU Quick Installation Guideline" to set up network and registering. The inverter status would be shown by mobile phone APP or webpage of computer.

RGB Light (option)

- ① **Battery Mode:red Light**
- ② **Utility Mode:blue Light**
- ③ **PV Mode:purple Light**

5 OPERATION

5.1 Power ON/OFF

Side view of unit

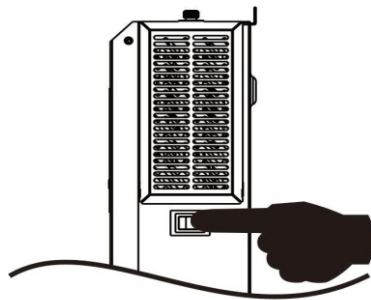

Once the unit has been properly installed and the batteries are connected well, simply press On/Off switch (located on the button of the case) to turn on the unit.

5.2 Operation and Display Panel

The operation and display panel, shown in below chart, is on the front panel of the inverter. It includes three indicators, four function keys and a LCD display, indicating the operating status and input/output power information.

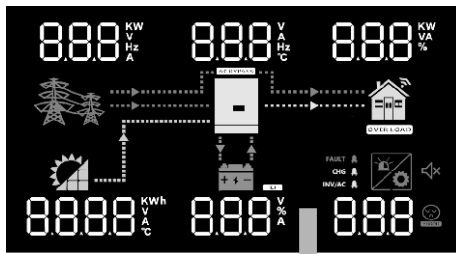

LCD display

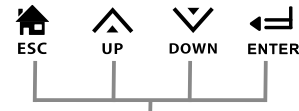

Function keys

LED Indicator

LED Indicator		Messages	
INV/AC	Green	Solid On	Output is powered by utility in Line mode.
		Flashing	Output is powered by battery or PV in battery mode.
CHG	Green	Solid On	Battery is fully charged.
		Flashing	Battery is charging.
FAULT	Red	Solid On	Fault occurs in the inverter.
		Flashing	Warning condition occurs in the inverter.







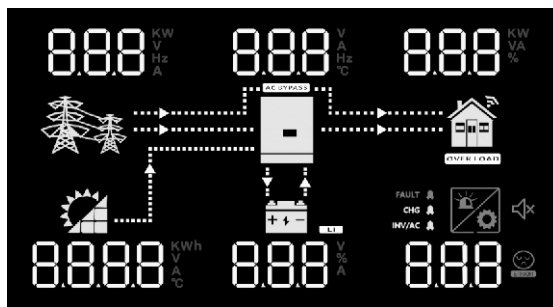







Function Keys

Function Key	Description
ESC	To exit setting mode
UP	To go to previous selection
DOWN	To go to next selection
ENTER	To confirm the selection in setting mode or enter setting mode

5.3 LCD Display Icons



Icon	Function description
Input Source Information	
	Indicates the AC input.
	Indicates the PV input
	Indicate input voltage, input frequency, PV voltage, charger current (if PV in charging for 3.6KW models), charger power, battery voltage.

Configuration Program and Fault Information	
	Indicates the setting programs.
	Indicates the warning and fault codes. Warning:  flashing with warning code.
	Fault:  lighting with fault code
Output Information	
	Indicate output voltage, output frequency, load percent, load in VA, load in Watt and discharging current.
Battery Information	
	
Load Information	
	
	Indicates overload.
Mode Operation Information	
	Indicates unit connects to the mains.
	Indicates unit connects to the PV panel.
	Indicates load is supplied by utility power.
	Indicates the utility charger circuit is working.
	Indicates the DC/AC inverter circuit is working.
Mute Operation	
	Indicates unit alarm is disabled.

5.4 LCD Setting

After pressing and holding ENTER button for 3 seconds, the unit will enter setting mode. Press "UP" or "DOWN" button to select setting programs. And then, press "ENTER" button to confirm the selection or ESC button to exit.

Setting Programs:

Program	Description	Selectable option	
00	Exit setting mode	Escape (default) 00 <u>GOE</u>	One-button restore setting options
		00 <u>GOH</u>	
01	Output source priority: To configure load power source priority	Utility first 01 <u>USb</u>	Utility will provide power to the loads as first priority. Solar and battery energy will provide power to the loads only when utility power is not available.
		Solar first (default) 01 <u>SUb</u>	Solar energy provides power to the loads as first priority. If solar energy is not sufficient to power all connected loads, utility will supply power to the loads at the same time. Battery provides power to the loads only when any one condition happens: - Solar energy and utility is not available. - Solar energy is not sufficient and utility is not available.
		SBU priority 01 <u>SbU</u>	Solar energy provides power to the loads as first priority. If solar energy is not sufficient to power all connected loads, battery energy will supply power to the loads at the same time. Utility provides power to the loads only when battery voltage drops to either low-level warning voltage or the setting point in program 12.
02	Maximum charging current: To configure total charging current for solar and utility chargers. (Max. charging current = utility charging current + solar charging current)	10A 02 <u>10^A</u>	20A 02 <u>20^A</u>
		30A 02 <u>30^A</u>	40A 02 <u>40^A</u>

02		50A 02 50 ^A	60A (default) 02 60 ^A		
		70A 02 70 ^A	80A 02 80 ^A		
		90A 02 90 ^A	100A 02 100 ^A	110A 02 110 ^A	
		120A 02 120 ^A	130A(for 4.2kw) 02 130 ^A	140A(for 4.2kw) 02 140 ^A	
03	AC input voltage range	Appliances (default) 03 APL	If selected, acceptable AC input voltage range will be within 90-280VAC.		
		UPS 03 UPS	If selected, acceptable AC input voltage range will be within 170-280VAC.		
05	Battery type	AGM (default) 05 AGM	Flooded 05 FLD		
		User-Defined 05 USE	If "User-Defined" is selected, battery charge voltage and low DC cut-off voltage can be set up in program 26, 27 and 29.		
		User-Defined 05 LIB	When the solar energy exists, Set this item to LIB, and the lithium battery will be activated for 3 second.		
06	Auto restart when overload occurs	Restart disable (default) 06 LTD	Restart enable 06 LTE		
07	Auto restart when over temperature occurs	Restart disable (default) 07 LTD	Restart enable 07 LTE		
09	Output frequency	50Hz (default) 09 50 ^{Hz}	60Hz 09 60 ^{Hz}		
10	Output voltage	220V 10 220 ^v	230V (default) 10 230 ^v		
		240V 10 240 ^v			
11	Maximum utility charging current Note: If setting value in program 02 is smaller than that in program in 11, the inverter will apply charging	2A 11 2A	10A 11 10A		
		20A 11 20A	30A (default) 11 30A		

	current from program 02 for utility charger.	40A 11 40A	50A 11 50A			
		60A 11 60A	70A 11 70A ⊗	80A 11 80A ⊗		
		90A 11 90A	100A 11 100A			
12	Setting voltage point back to utility source when selecting "SBU priority" or "Solar first" in program 01.	Available options in 3.6KW/4.2KW model:				
		21.0V 12 ^{BATT} 21.0v	21.5V 12 ^{BATT} 21.5v	22.0V 12 ^{BATT} 22.0v		
		22.5V 12 ^{BATT} 22.5v	23.0V (default) 12 ^{BATT} 23.0v	23.5V 12 ^{BATT} 23.5v		
		24.0V 12 ^{BATT} 24.0v	24.5V 12 ^{BATT} 24.5v			
		25.0V 12 ^{BATT} 25.0v	25.5V 12 ^{BATT} 25.5v			
		Available options in 6.2KW model:				
		42V 12 ^{BATT} 42v	43V 12 ^{BATT} 43v	44V 12 ^{BATT} 44v ⊗		
		45V 12 ^{BATT} 45v	46V (default) 12 ^{BATT} 46v	47V 12 ^{BATT} 47v		
		48V 12 ^{BATT} 48v	49V 12 ^{BATT} 49v			
		50V 12 ^{BATT} 50v	51V 12 ^{BATT} 51v			
		13	Setting voltage point back	Available options in 3.6KW/4.2KW model:		

to battery mode when selecting "SBU priority" or "Solar first" in program 01.	Battery fully charged	24V
	13 ^{BATT} FUL	13 ^{BATT} 24.0 _v
	24.5V	25V
	13 ^{BATT} 24.5 _v	13 ^{BATT} 25.0 _v
	25.5V	26V
	13 ^{BATT} 25.5 _v	13 ^{BATT} 26.0 _v
	26.5V	27V (default)
	13 ^{BATT} 26.5 _v	13 ^{BATT} 27.0 _v
	27.5V	28V
	13 ^{BATT} 27.5 _v	13 ^{BATT} 28.0 _v
	28.5V	29V
	13 ^{BATT} 28.5 _v	13 ^{BATT} 29.0 _v
	Available options in 6.2KW model:	
	Battery fully charged	48V
13 ^{BATT} FUL	13 ^{BATT} 48.0 _v	
49V	50V	
13 ^{BATT} 49.0 _v	13 ^{BATT} 50.0 _v	
51V	52V	
13 ^{BATT} 51.0 _v	13 ^{BATT} 52.0 _v	
53V	54V (default)	
13 ^{BATT} 53.0 _v	13 ^{BATT} 54.0 _v	

		55V 13 <u>55.0</u> ^{BATT} v	56V 13 <u>56.0</u> ^{BATT} v
		57V 13 <u>57.0</u> ^{BATT} v	58V 13 <u>58.0</u> ^{BATT} v
16	Charger source priority: To configure charger source priority	If this inverter/charger is working in Line, Standby or Fault mode, charger source can be programmed as below:	
		Solar first 16 <u>C50</u>	Solar energy will charge battery as first priority. Utility will charge battery only when solar energy is not available.
		Solar and Utility (default) 16 <u>SNU</u>	Solar energy and utility will charge battery at the same time.
		Only Solar 16 <u>050</u>	Solar energy will be the only charger source no matter utility is available or not.
		If this inverter/charger is working in Battery mode or Power saving mode, only solar energy can charge battery. Solar energy will charge battery if it's available and sufficient.	
18	Alarm control	Alarm on (default) 18 <u>60N</u>	Alarm off 18 <u>60F</u>
19	Auto return to default display screen	Return to default display screen (default) 19 <u>ESP</u>	If selected, no matter how users switch display screen, it will automatically return to default display screen (Input voltage /output voltage) after no button is pressed for 1 minute.
		Stay at latest screen 19 <u>LEP</u>	If selected, the display screen will stay at latest screen user finally switches.
20	Backlight control	Backlight on (default) 20 <u>L0N</u>	Backlight off 20 <u>L0F</u>

22	Beeps while primary source is interrupted	Alarm on (default) 22 AON	Alarm off 22 AOF
23	Overload bypass: When enabled, the unit will transfer to line mode if overload occurs in battery mode.	Bypass disable (default) 23 byd	Bypass enable 23 byE
25	Record Fault code	Record enable (default) 25 FEN	Record disable 25 FdS
26	Bulk charging voltage (C.V voltage)	3.6KW/4.2KW default setting: 28.2V CU 26 28.2 ^{BATT} v	
		6.2KW default setting: 56.4V CU 26 56.4 ^{BATT} v	
		If self-defined is selected in program 5, this program can be set up. Setting range is from 25.0V to 31.5V for 3.6KW/4.2KW model and 48.0V to 61.0V for 6.2KW model. Increment of each click is 0.1V.	
27	Floating charging voltage	3.6KW/4.2KW default setting: 27.0V FLU 27 27.0 ^{BATT} v	
		6.2KW default setting: 54.0V FLU 27 54.0 ^{BATT} v	
		If self-defined is selected in program 5, this program can be set up. Setting range is from 25.0V to 31.5V for 3.6KW/4.2KW model and 48.0V to 61.0V for 6.2KW model. Increment of each click is 0.1V.	
29	Low DC cut-off voltage	3.6KW/4.2KW default setting: 20.0V COU 29 20.0 ^{BATT} v	
		6.2KW default setting: 40.0V COU 29 40.0 ^{BATT} v	

		If self-defined is selected in program 5, this program can be set up. Setting range is from 20.0V to 24.0V for 3.6KW/4.2KW model and 40.0V to 48.0V for 6.2KW model. Increment of each click is 0.1V. Low DC cut-off voltage will be fixed to setting value no matter what percentage of load is connected.	
30	Battery equalization	Battery equalization 30 EEN	Battery equalization disable (default) 30 EdS
		If "Flooded" or "User-Defined" is selected in program 05, this program can be set up.	
31	Battery equalization voltage	3.6KW/4.2KW default setting: 29.2V EV 31 ^{BATT} 29.2 _v	
		6.2KW default setting: 58.4V EV 31 ^{BATT} 58.4 _v	
		Setting range is from 25.0V to 31.5V for 3.6KW/4.2KW model and 48.0V to 61.0V for 6.2KW model. Increment of each click is 0.1V.	
33	Battery equalized time	60min (default) 33 60	Setting range is from 5min to 900min. Increment of each click is 5min.
34	Battery equalized timeout	120min (default) 34 120	Setting range is from 5min to 900 min. Increment of each click is 5 min.
35	Equalization interval	30days (default) 35 30d	Setting range is from 0 to 90 days. Increment of each click is 1 day
36	Equalization activated immediately	Enable 36 AEN	Disable (default) 36 AdS
		If equalization function is enabled in program 30, this program can be set up. If "Enable" is selected in this program, it's to activate battery equalization immediately and LCD main page will shows "E9". If "Disable" is selected, it will cancel equalization function until next activated equalization time arrives based on program 35 setting. At this time, "E9" will not be shown in LCD main page.	
37	GRID-tie operation	Off grid (default) 37 OFF	Inverter operates only in off-grid mode. Solar energy provides power to the loads as first priority and charging second
		Hybrid 37 HYD	Inverter operates hybrid mode. Solar energy provides power to the loads as first priority and charging second Excess energy feed to grid.

38	GRID-tie current	10A 38 10 ^A	Increment of each click is 2A.
39	Led pattern light	Led pattern off 39 L0F	Led pattern on(default) 39 L0N

5.5 Display Setting

The LCD display information will be switched in turns by pressing "UP" or "DOWN" key. The selectable information is switched as below order: input voltage, input frequency, PV voltage, charging current, charging power, battery voltage, output voltage, output frequency, load percentage, load in Watt, load in VA, load in Watt, DC discharging current, main CPU Version.

Selectable information	LCD display
Charged state, and the power is less than 1kw	
Input voltage=222V , PV voltage=168V, Battery voltage=25V, Output voltage=222V, Load in Watt=188W, Chg(Flashing), Inv/ac(bright)	
Input voltage=223V , PV current=2.3A, Battery current=20A, Output voltage=224V, Load in VA=188VA, Chg(Flashing), Inv/ac(bright)	
Input voltage=223V , Pv ntc temperture=71.0°C, Battery voltage= 25V, Inv ntc temperture=35.0°C, Load percentage=12% , Chg(Flashing), Inv/ac(bright)	

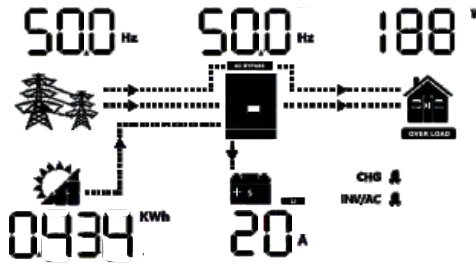
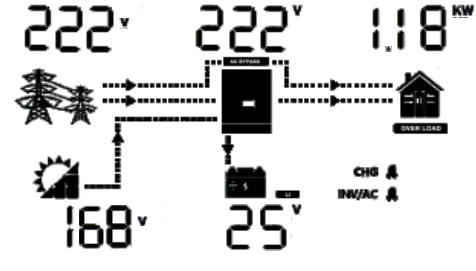
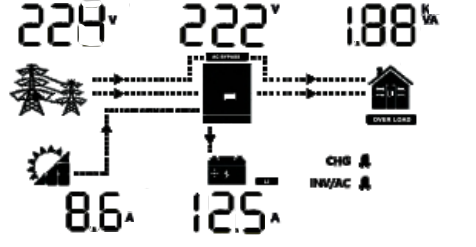
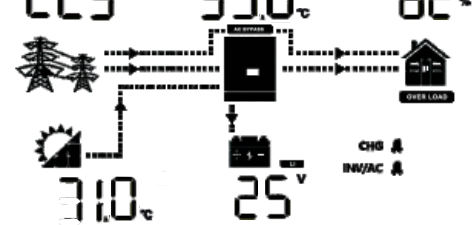
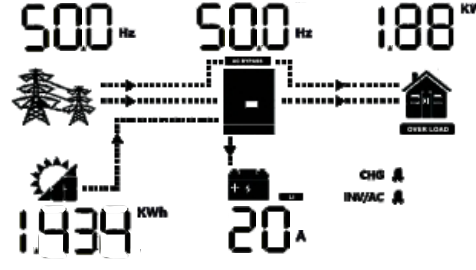
<p>Input frequency=50.0Hz , PV power=0.434KWh, Battery current=20A, Output frequency=50.0Hz, Load in watt=188W, Chg(Flashing), Inv/ac(bright)</p>	
<p>Charged state, and the power is greater than 1kw</p>	
<p>Input voltage=222V , PV voltage=168V, Battery voltage=25V, Output voltage=222V, Load in Watt=1.18KW, Chg(Flashing), Inv/ac(bright)</p>	
<p>Input voltage=224V , PV current=8.6A, Battery current=12.5A, Output voltage=222V, Load in VA=1.88KVA, Chg(Flashing), Inv/ac(bright)</p>	
<p>Input voltage=223V , Pv ntc temperture=71.0°C, Battery voltage=25V, Inv ntc temperture=35.0°C, Load percentage=82% , Chg(Flashing), Inv/ac(bright)</p>	
<p>Input frequency=50.0Hz , PV power=1.434KWh, Battery current=20A, Output frequency=50.0Hz, Load in watt=1.88KW, Chg(Flashing), Inv/ac(bright)</p>	

Discharged state, and the power is less than 1kw

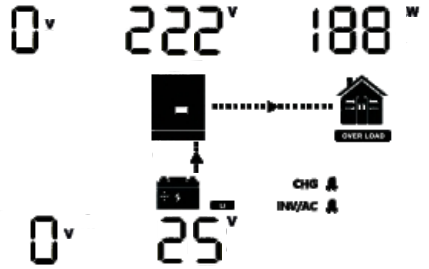
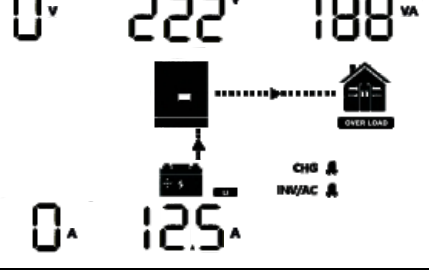
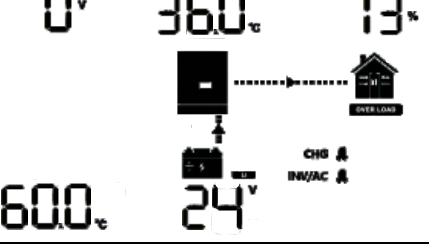
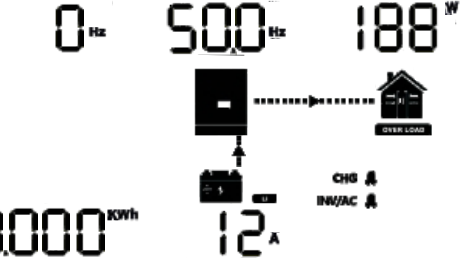
<p>Input voltage=0V , PV voltage=0V, Battery voltage=25V, Output voltage=222V, Load in Watt=188W, Chg(turn off), Inv/ac(Flashing)</p>	
<p>Input voltage=0V , PV current=0A, Battery current=12.5A, Output voltage=222V, Load in VA=188VA, Chg(turn off), Inv/ac(Flashing)</p>	
<p>Input voltage=0V , Pv ntc temperture=60.0°C, Battery voltage= 24V, Inv ntc temperture=36.0°C, Load percentage=13% , Chg(turn off), Inv/ac(Flashing)</p>	
<p>Input frequency=0Hz , PV power=0KWh, Battery current=12A, Output frequency=50.0Hz, Load in watt=188W, Chg(turn off), Inv/ac(Flashing)</p>	

Discharged state, and the power is greater than 1kw

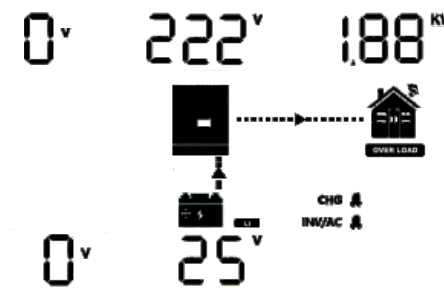
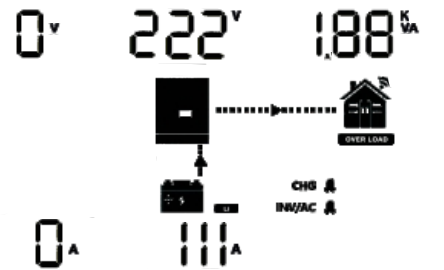
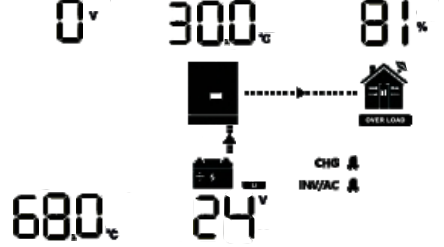
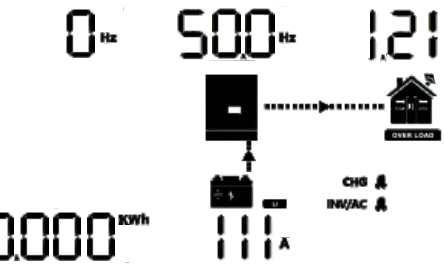
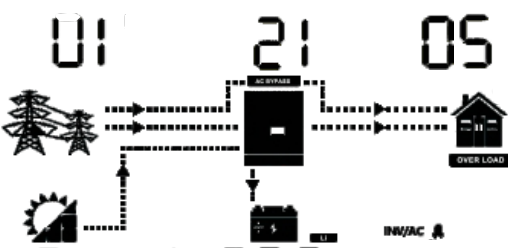
<p>Input voltage=0V , PV voltage=0V, Battery voltage=25V, Output voltage=222V, Load in Watt=1.88KW, Chg(turn off), Inv/ac(Flashing)</p>	
<p>Input voltage=0V , PV current=0A, Battery current=111A, Output voltage=222V, Load in VA=1.88KVA, Chg(turn off), Inv/ac(Flashing)</p>	
<p>Input voltage=0V , Pv ntc temperture=68.0°C, Battery voltage= 24V, Inv ntc temperture=30.0°C, Load percentage=81%, Chg(turn off), Inv/ac(Flashing)</p>	
<p>Input frequency=0Hz , PV power=0KWh, Battery current=111A, Output frequency=50.0Hz, Load in watt=1.21KW, Chg(turn off), Inv/ac(Flashing)</p>	
<p>Main CPU version checking</p>	<p>Main CPU version 21 05</p> 

5.6 Operating Mode Description

Operation mode	Selectable information	LCD display
Standby mode	Input voltage=222V , PV voltage=210V, Battery voltage=25V, Output voltage=0V, Load in Watt=0W, Chg(Flashing), Inv/ac(bright)	
	Input voltage=223V , PV voltage=0V, Battery voltage=25V, Output voltage=0V, Load in Watt=0W, Chg(Flashing), Inv/ac(bright)	
	Input voltage=0V , PV voltage=210V, Battery voltage=25V, Output voltage=0V, Load in Watt=0W, Chg(Flashing)	
Line mode	Input voltage=224V , PV current=8.6A, Battery current=12.5A, Output voltage=222V, Load in VA=1.88KVA, Chg(Flashing), Inv/ac(bright)	
	Input voltage=224V , PV voltage=0V, Battery voltage=25V, Output voltage=222V, Load in Watt=188W, Chg(Flashing), Inv/ac(bright)	
Grid-Tie Operation	Input voltage=224V , PV current=8.6A, Battery current=12.5A, Output voltage=222V, Load in VA=1.88KVA, Chg(Flashing), Inv/ac(bright)	
		When working in Grid-Tie mode, the will be flash 3S/times.

Operation mode	Selectable information	LCD display
Battery mode	Input voltage=0V , PV voltage=180V, Battery voltage=25V, Output voltage=230V, Load in Watt=388W, Inv/ac(Flashing)	
	Input voltage=0V , PV voltage=180V, Battery voltage=25V, Output voltage=230V, Load in Watt=388W, Chg(Flashing), Inv/ac(Flashing)	

5.7 Battery Equalization Description

Equalization function is added into charge controller. It reverses the buildup of negative chemical effects like stratification, a condition where acid concentration is greater at the bottom of the battery than at the top. Equalization also helps to remove sulfate crystals that might have built up on the plates. If left unchecked, this condition, called sulfation, will reduce the overall capacity of the battery. Therefore, it's recommended to equalize battery periodically.

⌘ How to Apply Equalization Function

You must enable battery equalization function in monitoring LCD setting program 30 first. Then, you may apply this function in device by either one of following methods:

1. Setting equalization interval in program 35.
2. Active equalization immediately in program 36.

⌘ When to Equalize

In float stage, when the setting equalization interval (battery equalization cycle) is arrived, or equalization is active immediately, the controller will start to enter Equalize stage.

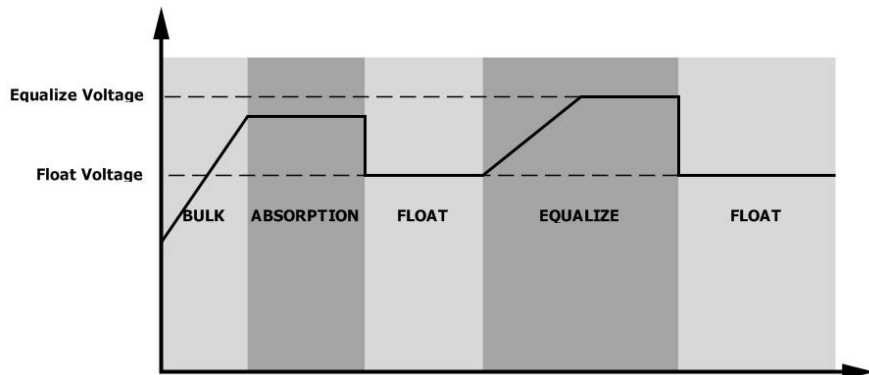

⌘ Equalize charging time and timeout

In Equalize stage, the controller will supply power to charge battery as much as possible until battery voltage raises to battery equalization voltage. Then, constant-voltage regulation is applied to maintain battery voltage at the battery equalization voltage. The battery will remain in the Equalize stage until setting battery equalized time is arrived.

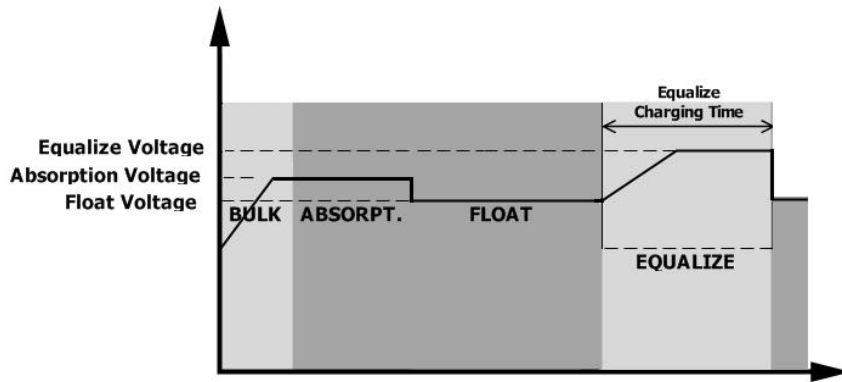

However, in Equalize stage, when battery equalized time is expired and battery voltage doesn't rise to battery equalization voltage point, the charge controller will extend the battery equalized time until battery voltage achieves battery equalization voltage. If battery voltage is still lower than battery equalization voltage when battery equalized timeout setting is over, the charge controller will stop equalization and return to float stage.

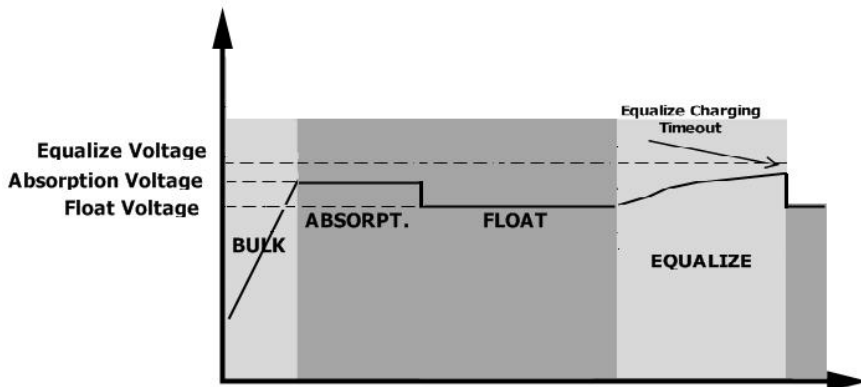

5.8 Fault Reference Code

Fault Code	Fault Event	Icon on
01	Fan is locked when inverter is off.	01 ERROR
02	Over temperature	02 ERROR
03	Battery voltage is too high	03 ERROR
04	Battery voltage is too low	04 ERROR
05	Output short circuited or over temperature is detected by internal converter components.	05 ERROR
06	Output voltage is too high.	06 ERROR
07	Overload time out	07 ERROR
08	Bus voltage is too high	08 ERROR
09	Bus soft start failed	09 ERROR
51	Over current or surge	51 ERROR

52	Bus voltage is too low	52 <small>ERROR</small>
53	Inverter soft start failed	53 <small>ERROR</small>
55	Over DC voltage in AC output	55 <small>ERROR</small>
57	Current sensor failed	57 <small>ERROR</small>
58	Output voltage is too low	58 <small>ERROR</small>
59	PV voltage is over limitation	59 <small>ERROR</small>

5.9 Warning Indicator

Warning Code	Warning Event	Audible Alarm	Icon flashing
01	Fan is locked when inverter is on.	Beep three times every second	01 [⊕]
03	Battery is over-charged	Beep once every second	03 [⊕]
04	Low battery	Beep once every second	04 [⊕]
07	Overload	Beep once every 0.5 second	07 [⊕]
10	Output power derating	Beep twice every 3 seconds	10 [⊕]
15	PV energy is low.	Beep twice every 3 seconds	15 [⊕]
E9	Battery equalization	None	E9 [⊕]
bP	Battery is not connected	None	bP [⊕]

6 CLEARANCE AND MAINTENANCE FOR ANTI-DUST KIT

6.1 Overview

Every inverter is already installed with anti-dusk kit from factory. Inverter will automatically detect this kit and activate internal thermal sensor to adjust internal temperature. This kit also keeps dusk from your inverter and increases product reliability in harsh environment.

6.2 Clearance and Maintenance

Step 1: Please loosen the screw in counterclockwise direction on the top of the inverter.

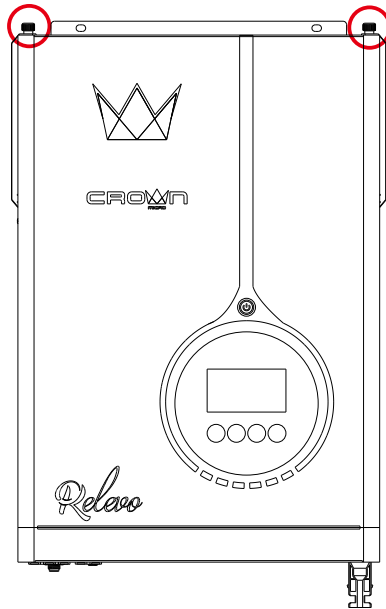

Step 2: Then, dustproof case can be removed and take out air filter foam as shown in below chart.

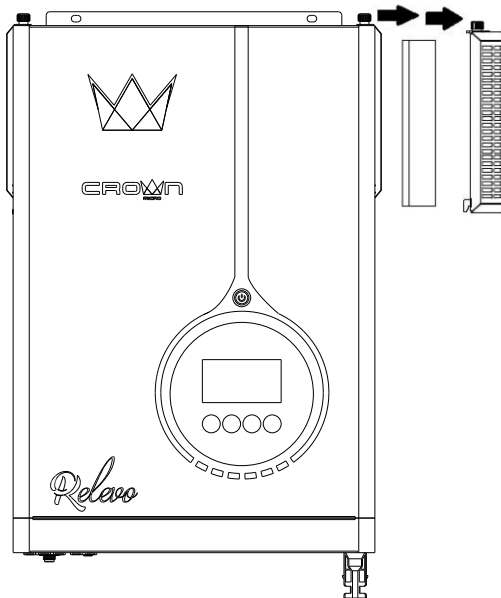

Step 3: Clean air filter foam and dustproof case. After clearance, re-assemble the dust-kit back to the inverter.

NOTICE: The anti-dust kit should be cleaned from dust every one month.

7 SPECIFICATIONS

Table 1 Line Mode Specifications

INVERTER MODEL	3.6KW	4.2KW	6.2KW
Input Voltage Waveform	Sinusoidal (utility or generator)		
Nominal Input Voltage	230Vac		
Low Loss Voltage	170Vac±7V (UPS); 90Vac±7V (Appliances)		
Low Loss Return Voltage	180Vac±7V (UPS); 100Vac±7V (Appliances)		
High Loss Voltage	280Vac±7V		
High Loss Return Voltage	270Vac±7V		
Max AC Input Voltage	300Vac		
Nominal Input Frequency	50Hz / 60Hz (Auto detection)		
Low Loss Frequency	40±1Hz		
Low Loss Return Frequency	42±1Hz		
High Loss Frequency	65±1Hz		
High Loss Return Frequency	63±1Hz		
Output Short Circuit Protection	Circuit Breaker		
Efficiency (Line Mode)	>95% (Rated R load, battery full charged)		
Transfer Time	10ms typical (UPS); 20ms typical (Appliances)		
<p>Output power derating: When AC input voltage drops to 170V, the output power will be derated.</p>	<p>The graph illustrates the output power derating characteristics. The vertical axis represents Output Power, with a horizontal dotted line for Rated Power and a lower horizontal dotted line for 50% Power. The horizontal axis represents Input Voltage, with markers at 90V, 170V, and 280V. The power curve starts at zero, rises vertically to 50% Power at 90V, then rises linearly to Rated Power at 170V. It remains constant at Rated Power until 280V, after which it drops vertically to zero.</p>		

Table 2 Inverter Mode Specifications

INVERTER MODEL	3.6KW	4.2KW	6.2KW
Rated Output Power	3.6KW	4.2KW	6.2KW
Output Voltage Waveform	Pure Sine Wave		
Output Voltage Regulation	230Vac±5%		
Output Frequency	50Hz		
Peak Efficiency	93%		
Overload Protection	3s@≥150% load; 5s@101%~150% load		
Surge Capacity	2* rated power for 5 seconds		
Nominal DC Input Voltage	24Vdc		48Vdc
Cold Start Voltage	23.0Vdc		46.0Vdc
Low DC Warning Voltage @ load < 50% @ load ≥ 50%	22.0Vdc 21.0Vdc		44.0Vdc 42.0Vdc
Low DC Warning Return Voltage @ load < 50% @ load ≥ 50%	22.5Vdc 22.0Vdc		45.0Vdc 44.0Vdc
Low DC Cut-off Voltage @ load < 50% @ load ≥ 50%	20.5Vdc 20.0Vdc		41.0Vdc 40.0Vdc
High DC Recovery Voltage	32Vdc		62Vdc
High DC Cut-off Voltage	33Vdc		63Vdc
No Load Power Consumption	35W	42W	62W

Table 3 Charge Mode Specifications

Utility Charging Mode			
INVERTER MODEL	3.6KW	4.2KW	6.2KW
Charging Algorithm		3-Step	
AC Charging Current (Max)		100Amp (@ $V_{I/P}=230V_{ac}$)	100Amp (@ $V_{I/P}=230V_{ac}$)
Bulk Charging Voltage	Flooded Battery	29.2	58.4
	AGM / Gel Battery	28.2	56.4
Floating Charging Voltage		27Vdc	54Vdc
Charging Curve			
MPPT Solar Charging Mode			
INVERTER MODEL	3.6KW	4.2KW	6.2KW
Max. PV Array Power	6200W	6200W	6500W
Nominal PV Voltage	240Vdc		360Vdc
PV Array MPPT Voltage Range	90Vdc~450Vdc		
Max. PV Array Open Circuit Voltage	500Vdc		
Max Charging Current (AC charger plus solar charger)	120Amp	140Amp	120Amp

Table 4 Grid-Tie Operation

INVERTER MODEL	3.6KW	4.2KW	6.2KW
Nominal Output Voltage	220/230/240 VAC		
Feed-in Grid Voltage Range	195 ~ 253VAC		
Feed-in Grid Frequency Range	49~51 ± 1Hz / 59~61 ± 1Hz		
Nominal Output Current	15.7A	18.2A	26.9A
Power Factor Range	>0.99		
Maximum Conversion Efficiency (DC/AC)	97%		

Table 5 General Specifications

INVERTER MODEL	3.6KW	4.2KW	6.2KW
Safety Certification	CE		
Operating Temperature Range	-10°C to 50°C		
Storage temperature	-15°C~ 60°C		
Humidity	5% to 95% Relative Humidity (Non-condensing)		
Dimension (D*W*H), mm	100 x 300 x 444		
Net Weight, kg	10	10.5	11

8 TROUBLE SHOOTING

Problem	LCD/LED/Buzzer	Explanation / Possible cause	What to do
Unit shuts down automatically during startup process.	LCD/LEDs and buzzer will be active for 3 seconds and then complete off.	The battery voltage is too low (<1.91V/Cell)	1. Re-charge battery. 2. Replace battery.
No response after power on.	No indication.	1. The battery voltage is far too low. (<1.4V/Cell) 2. Internal fuse tripped.	1. Contact repair center for replacing the fuse. 2. Re-charge battery. 3. Replace battery.
Mains exist but the unit works in battery mode.	Input voltage is displayed as 0 on the LCD and green LED is flashing.	Input protector is tripped	Check if AC breaker is tripped and AC wiring is connected well.
	Green LED is flashing.	Insufficient quality of AC power. (Shore or Generator)	1. Check if AC wires are too thin and/or too long. 2. Check if generator (if applied) is working well or if input voltage range setting is correct. (UPS↔ Appliance)
	Green LED is flashing.	Set "Solar First" as the priority of output source.	Change output source priority to Utility first.
When the unit is turned on, internal relay is switched on and off repeatedly.	LCD display and LEDs are flashing	Battery is disconnected.	Check if battery wires are connected well.
Buzzer beeps continuously and red LED is on.	Fault code 07	Overload error. The inverter is overload 110% and time is up.	Reduce the connected load by switching off some equipment.
	Fault code 05	Output short circuited.	Check if wiring is connected well and remove abnormal load.
		Temperature of internal converter component is over 120°C.	Check whether the air flow of the unit is blocked or whether the ambient temperature is too high.
	Fault code 02	Internal temperature of inverter component is over 100°C.	
	Fault code 03	Battery is over-charged.	Return to repair center.
		The battery voltage is too high.	Check if spec and quantity of batteries are meet requirements.
	Fault code 01	Fan fault	Replace the fan.
	Fault code 06/58	Output abnormal (Inverter voltage below than 190Vac or is higher than 260Vac)	1. Reduce the connected load. 2. Return to repair center
	Fault code 08/09/53/57	Internal components failed.	Return to repair center.
	Fault code 51	Over current or surge.	Restart the unit, if the error happens again, please return to repair center.
Fault code 52	Bus voltage is too low.		
Fault code 55	Output voltage is unbalanced.		

9 Appendix: Approximate Back-up Time Table

Model	Load (W)	Backup Time @ 24Vdc 100Ah (min)	Backup Time @ 24Vdc 200Ah (min)
3.6KW 4.2KW	300	449	1100
	600	222	525
	900	124	303
	1200	95	227
	1500	68	164
	1800	56	126
	2100	48	108
	2400	35	94
	2700	31	74
	3200	28	67
	3600	25	60
	4200	22	53

Model	Load (W)	Backup Time @ 48Vdc 100Ah (min)	Backup Time @ 48Vdc 200Ah (min)
6.2KW	500	613	1288
	1000	268	613
	1500	158	402
	2000	111	271
	2500	90	215
	3200	76	182
	3500	65	141
	4000	50	112
	4500	44	100
	5000	40	90
	6200	36	80

- Note:** 1. Backup time depends on the quality of the battery, age of battery and type of battery.
 Specifications of batteries may vary depending on different manufacturers.
 2. The final interpretation right of this product belongs to the company.

技术要求：单页尺寸142*210mm；
材质：封面105g铜版纸,内页80g书写纸；
料号打于后封面左下角；
注：此技术要求不用印刷